



PLANIMOLDE, S.A.
mau dhokoro

*" If accumulated experience is our identity,
And our humility, the proof of our intelligence,
Innovation is for us a constant disquietude."*

Telmo Ferraz – General Director





Founded in 1978

Nr. Employees: 50

Products: medium sized injection moulds

Production location: Marinha Grande, Portugal (1 hour from Lisbon airport)

Production area: 2.500m²

Target Industries: Automotive 74% | Housewares 10% | Others 16%

Export Rate: 78% to over 7 countries

Over 80 moulds per year







CNC High Speed Milling

3 & 5 axes machines

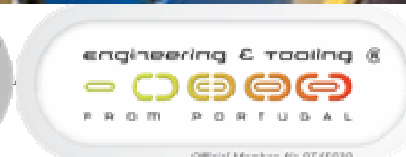
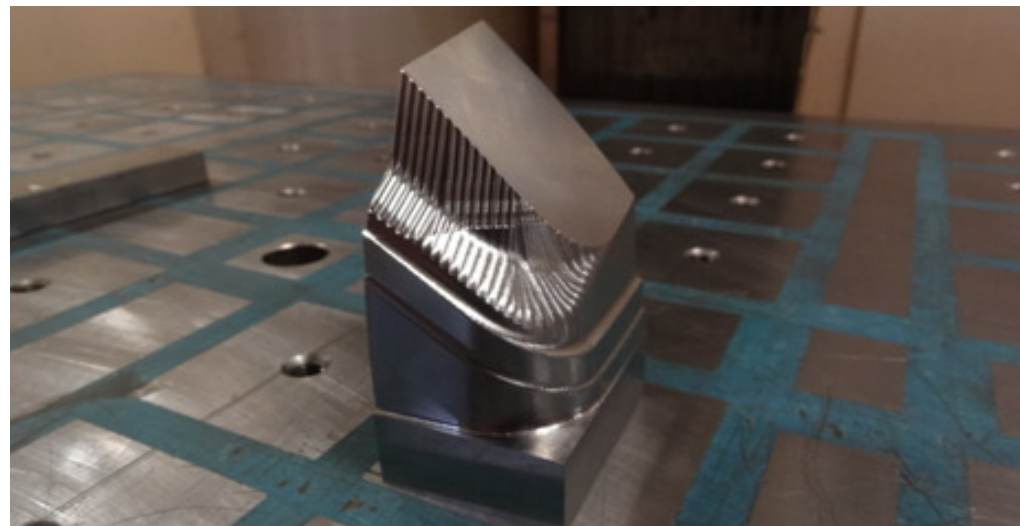



EDM

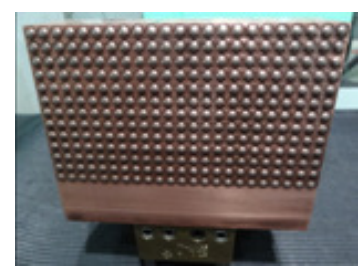



Grinding





Drilling & Dimensional Control

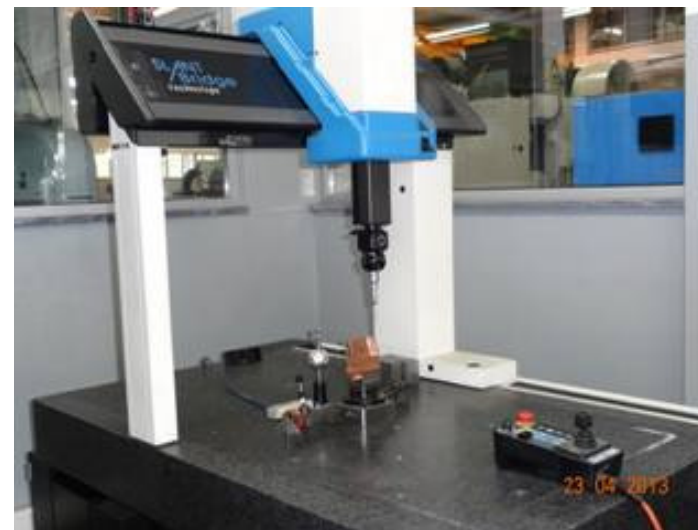



□ Complex Moulds

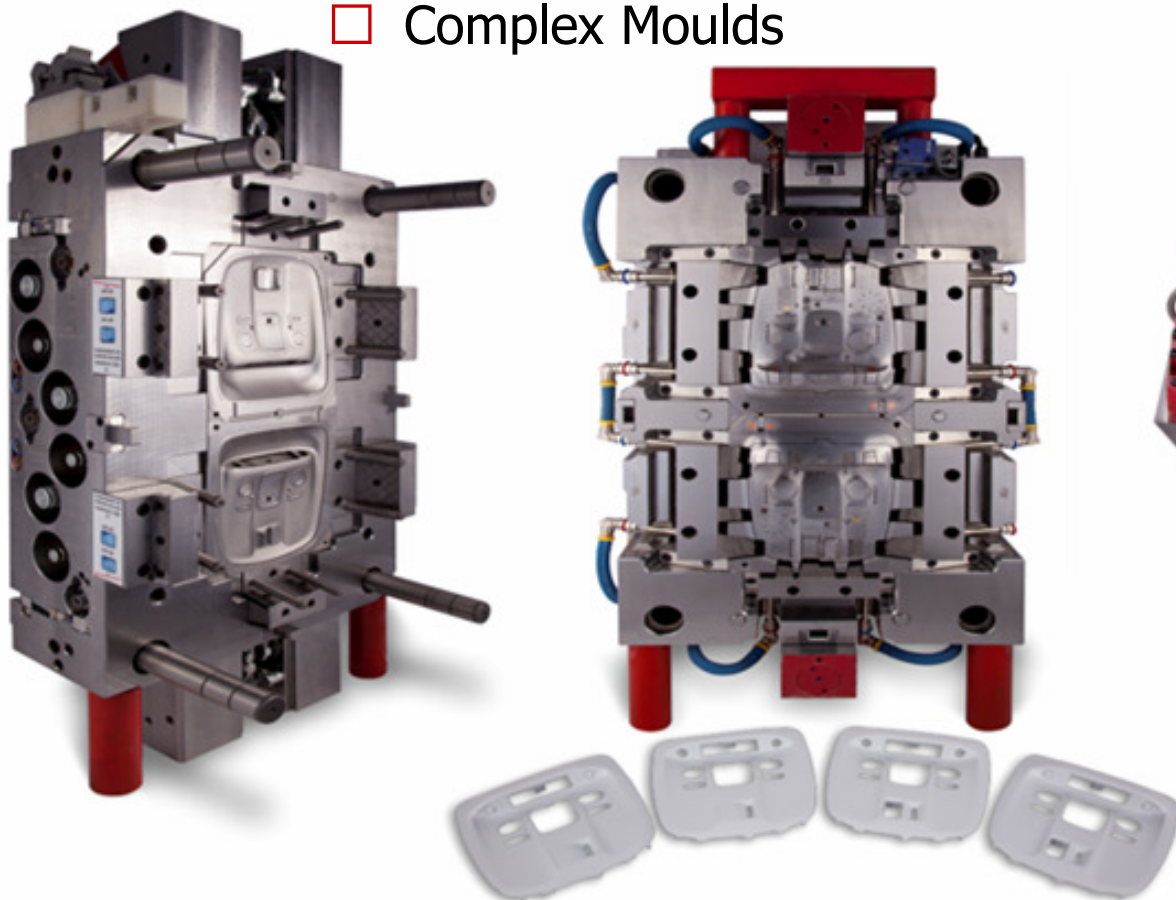

- 2 cavities mould with interchangeable inserts on the injection machine, in order to produce 4 different versions.

- **Movements:**

- > 3 (x2) hydraulical slides
- > 10 (x2) mechanical slides
- > 18 (x2) jiggle bars

- Intermediate plate on injection side for hydraulical cylinders

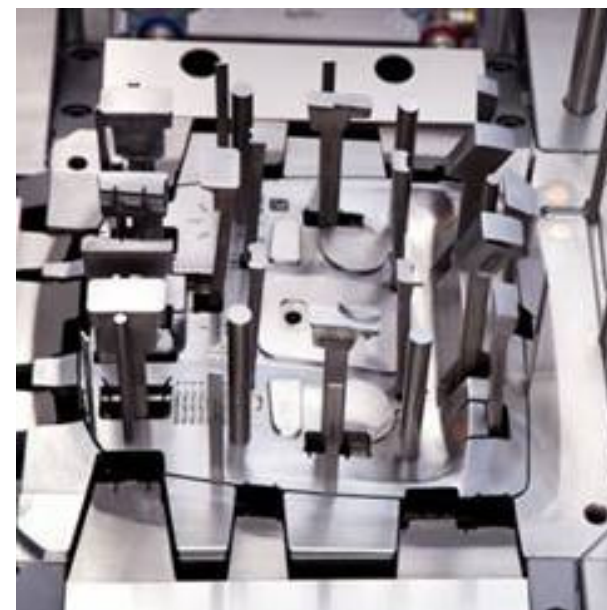
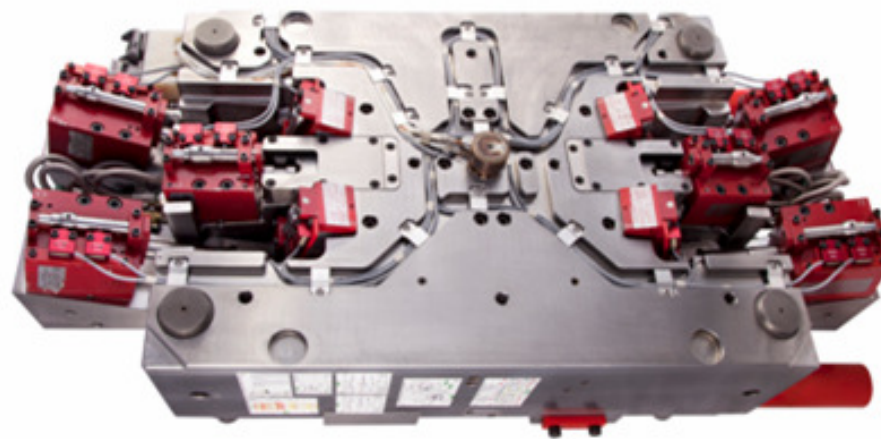



□ Complex Moulds

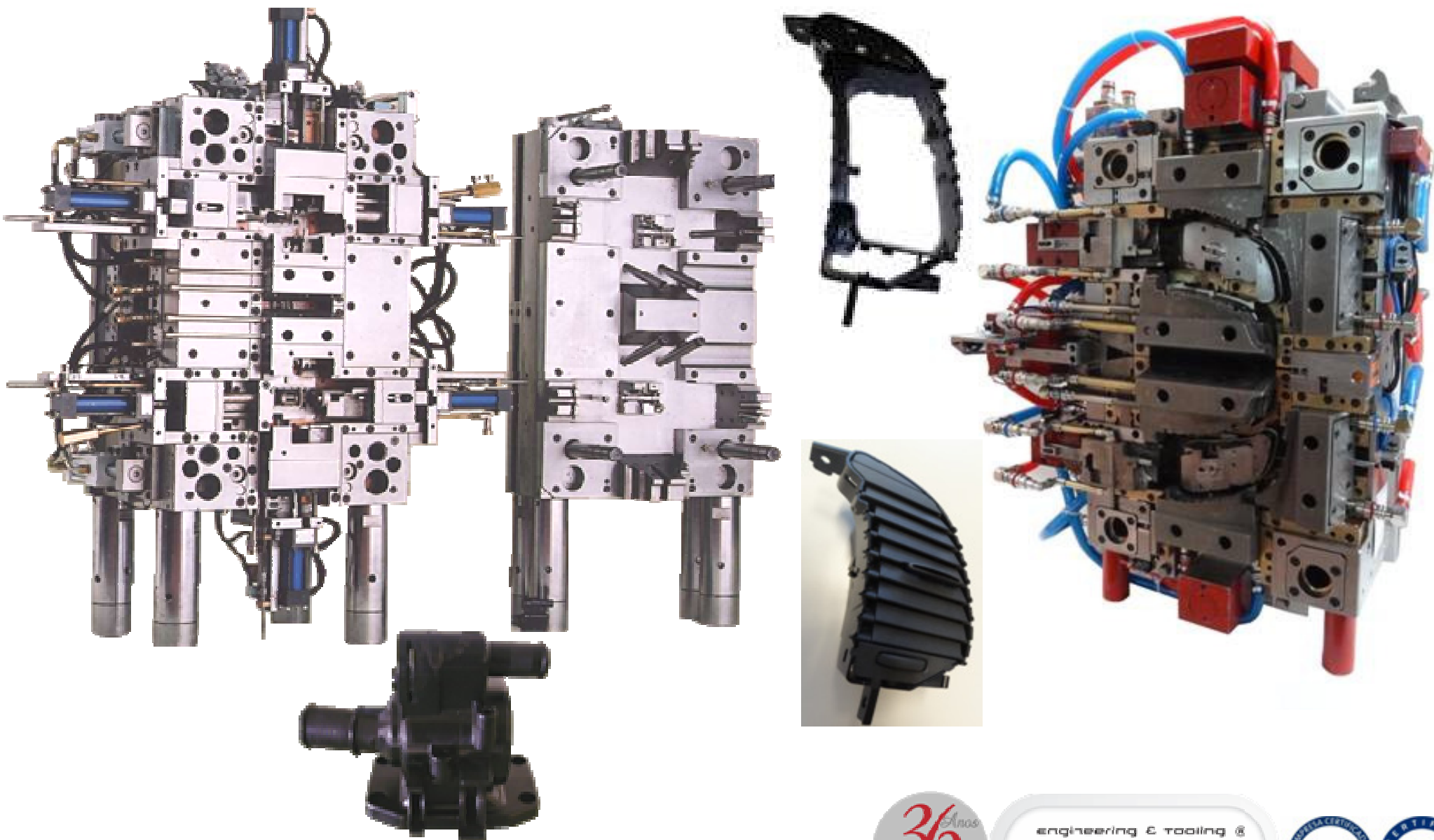



□ Complex Moulds

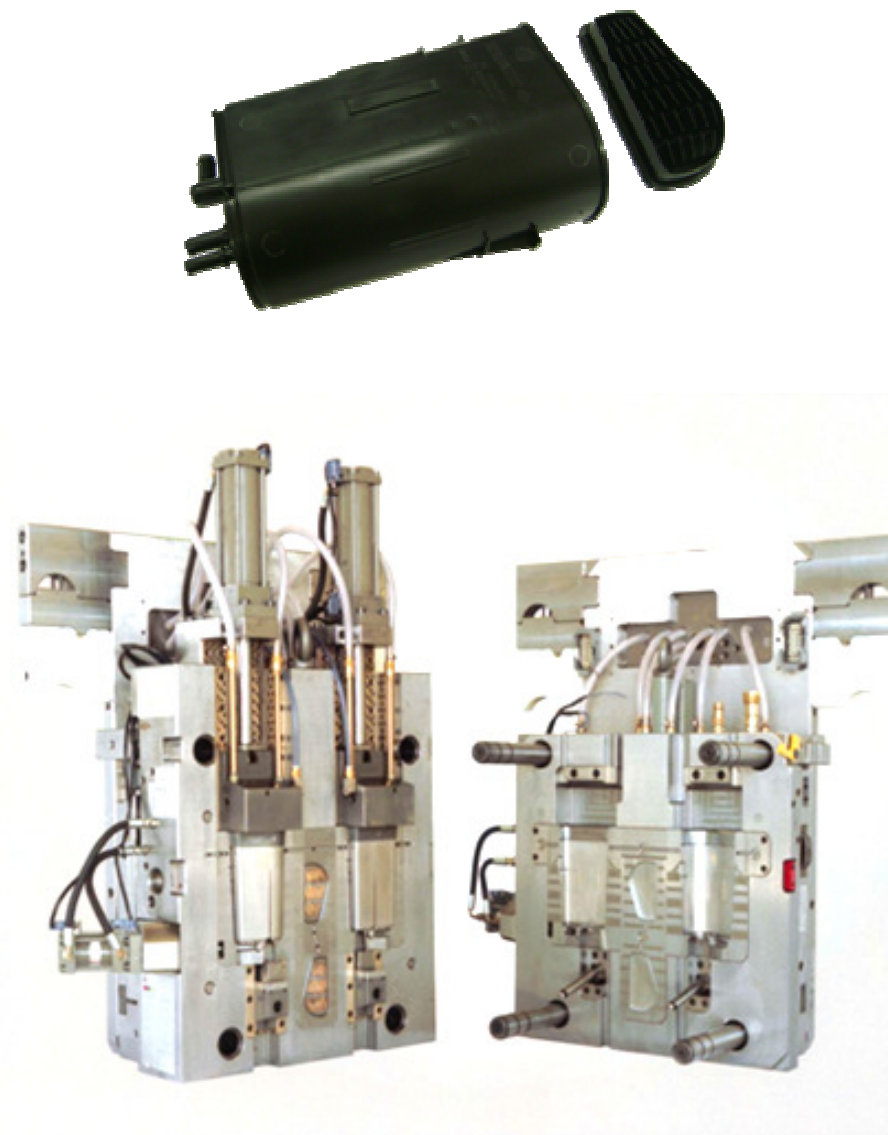
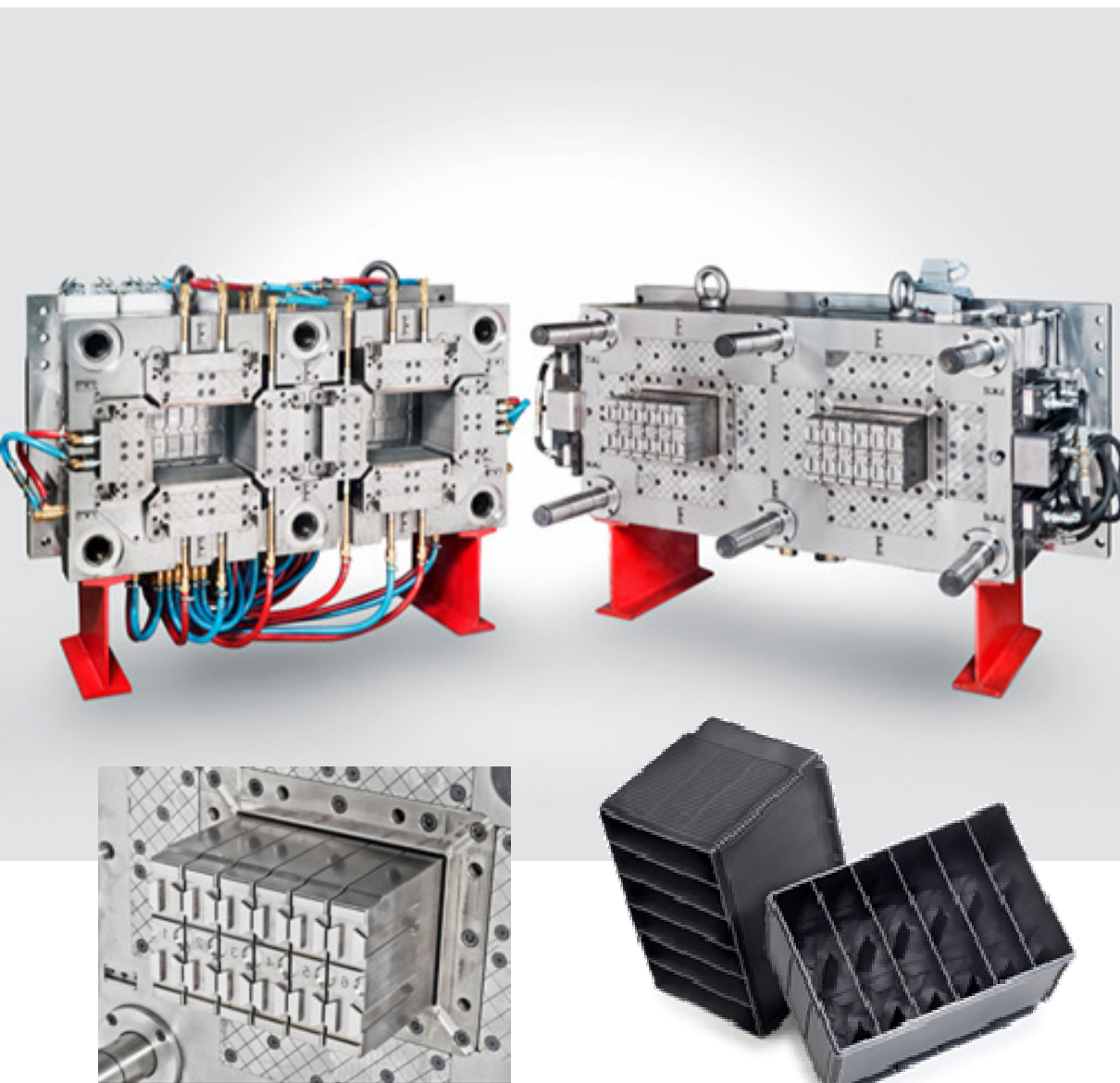



□ Complex Moulds

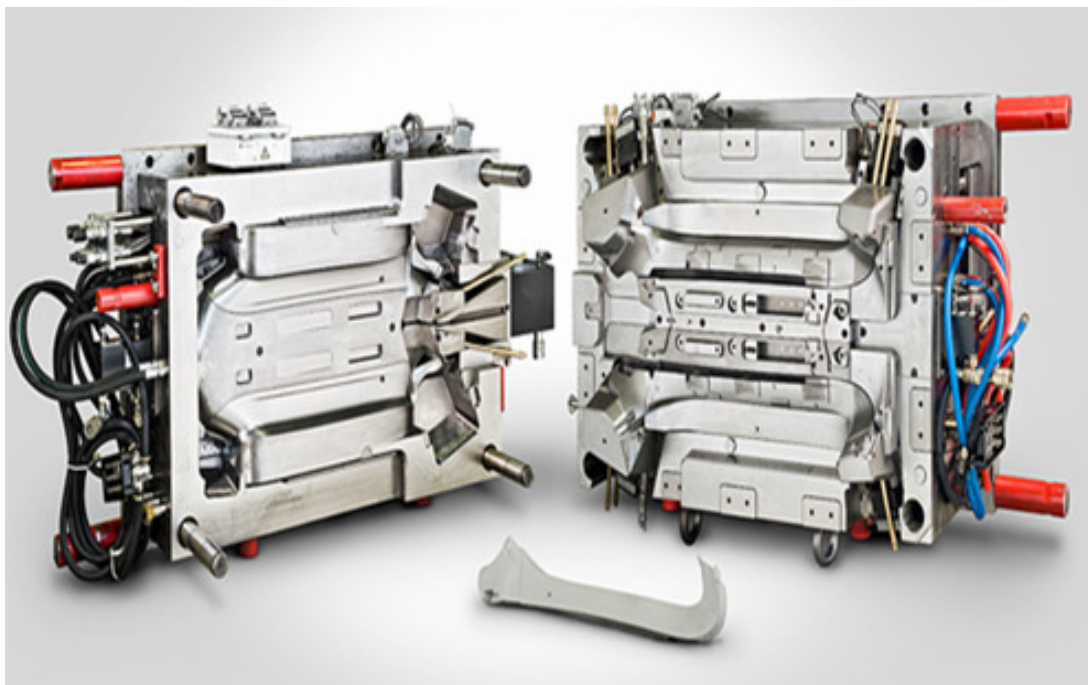

□ Multicavities

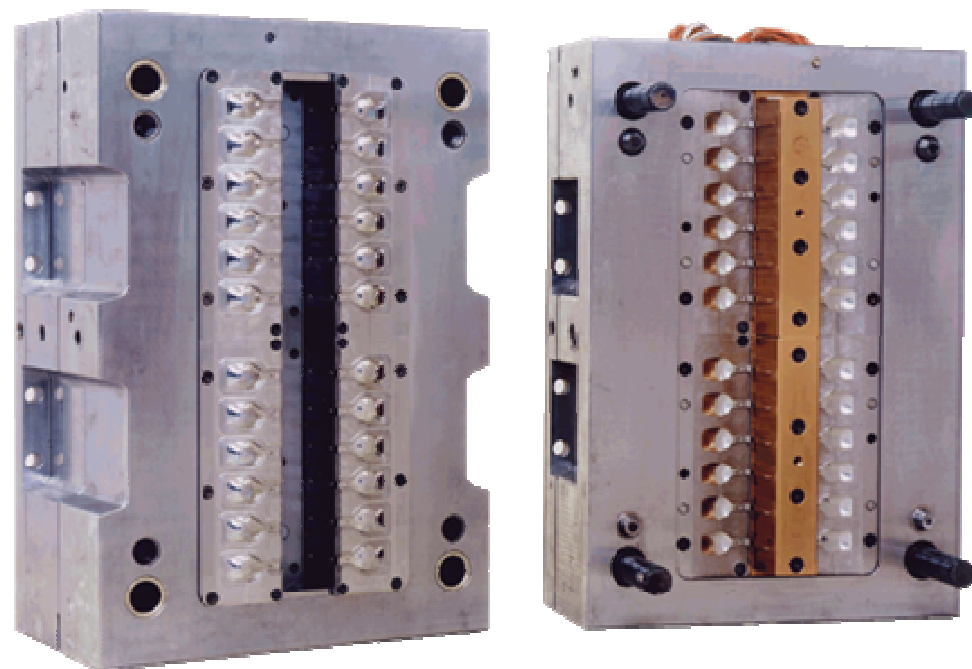
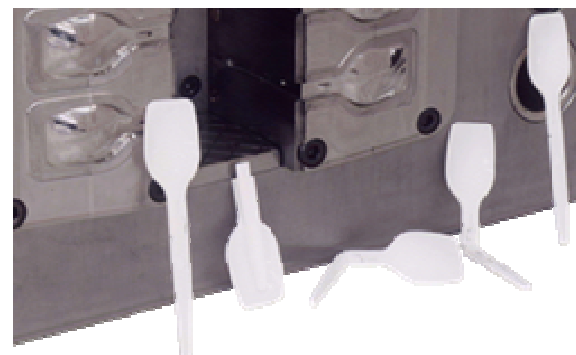



□ 3K Rotative Moulds

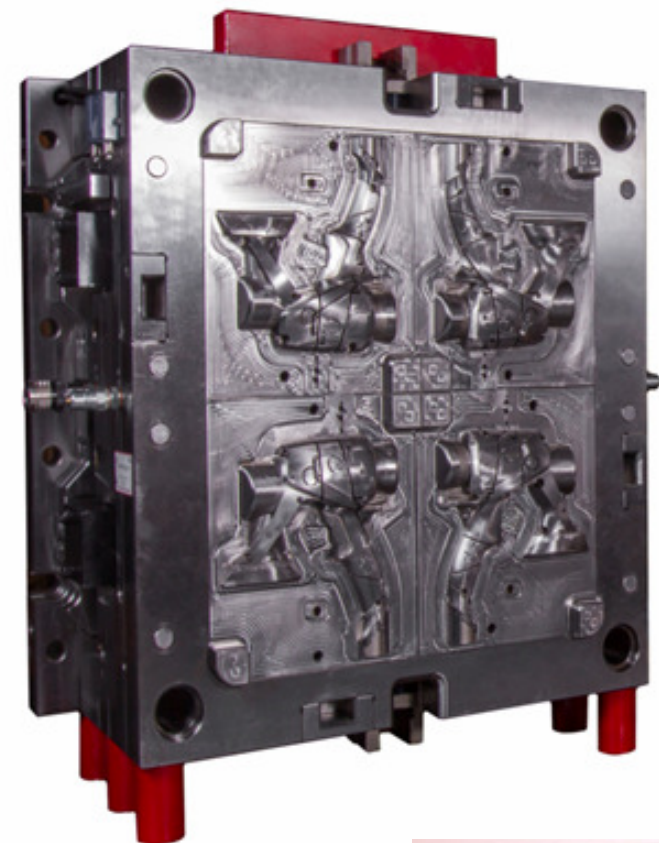



□ 2K Rotative Moulds

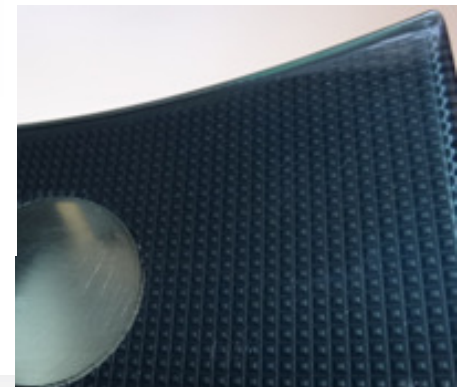
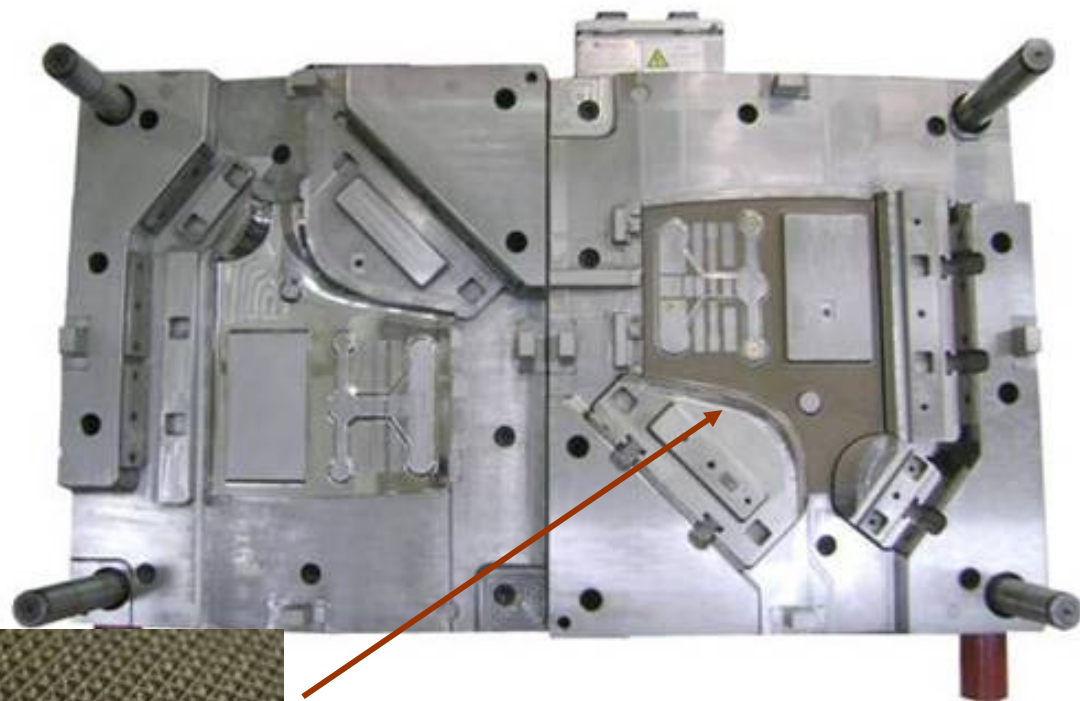
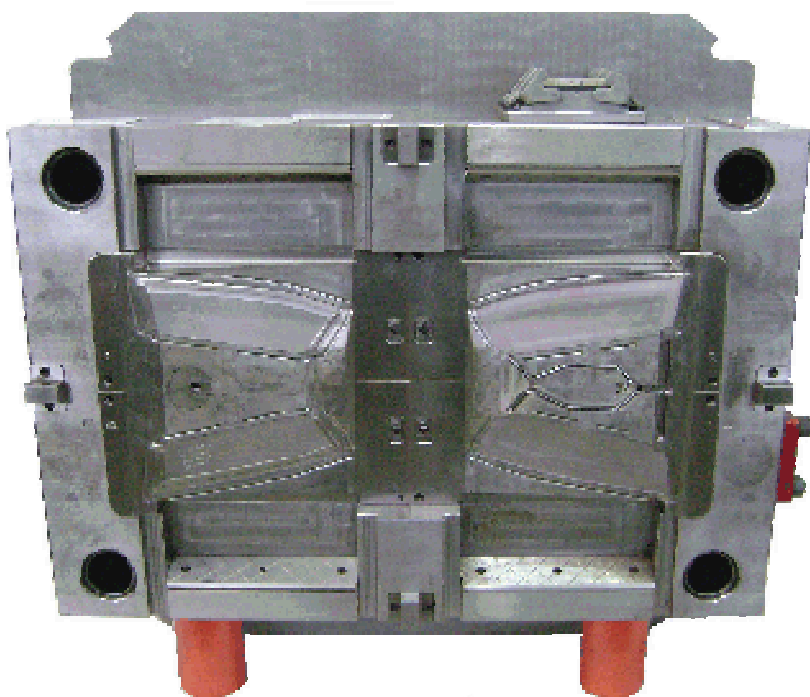



□ 2K Rotative Axe Mould

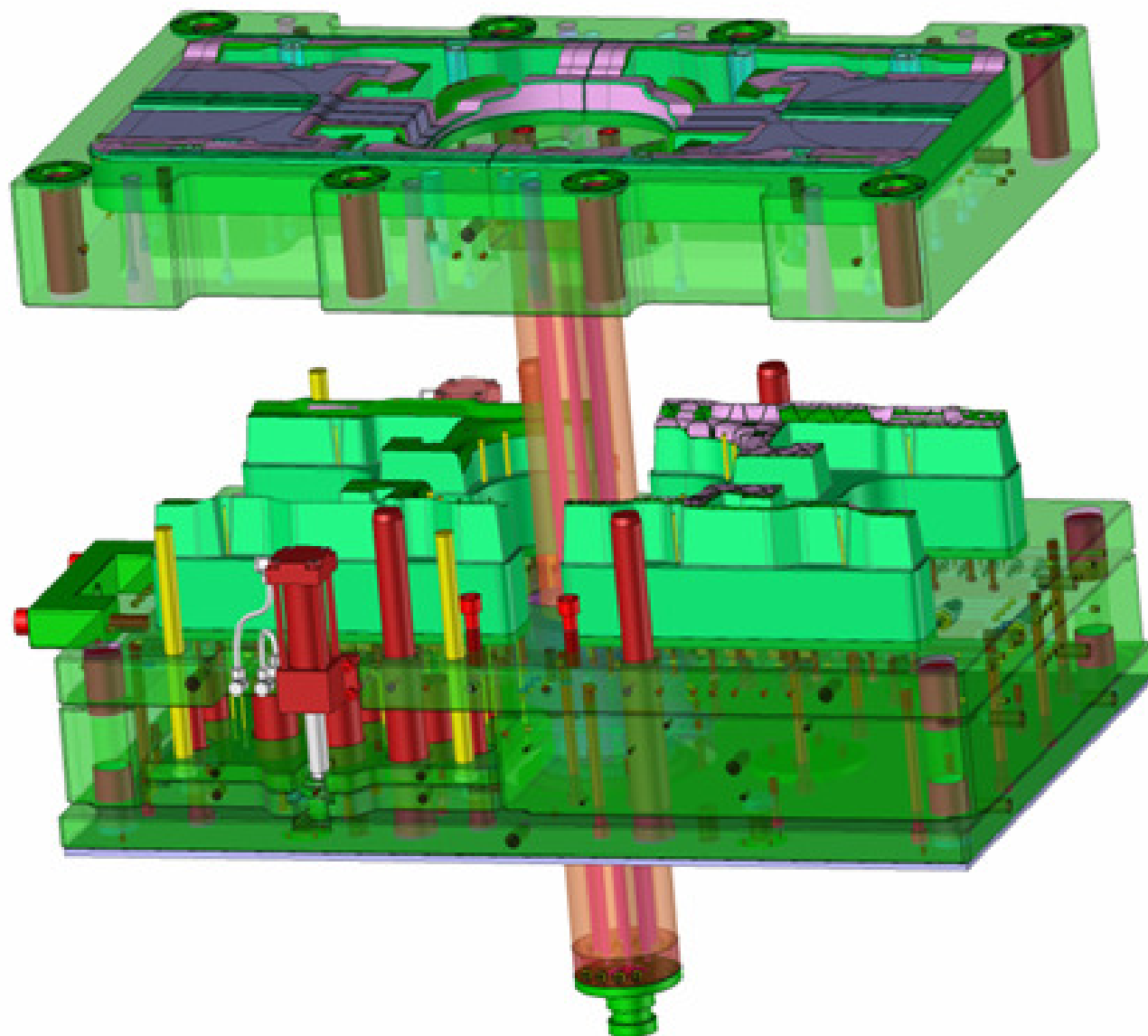
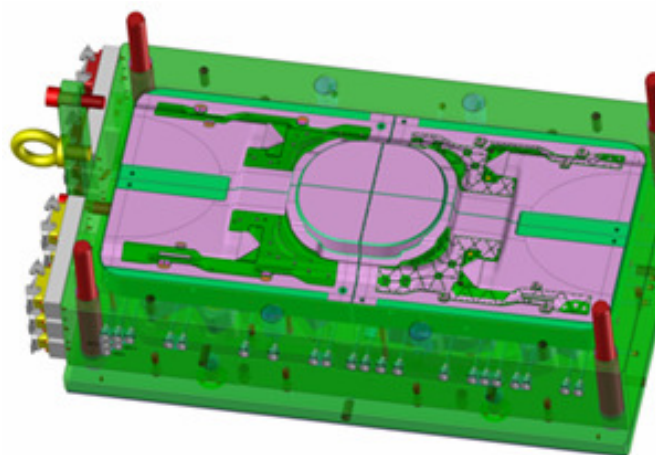



□ 2K Micro-Injection mould

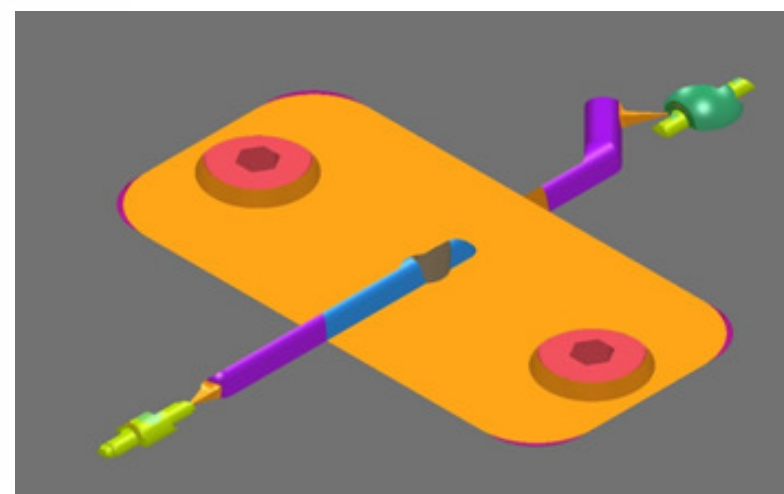
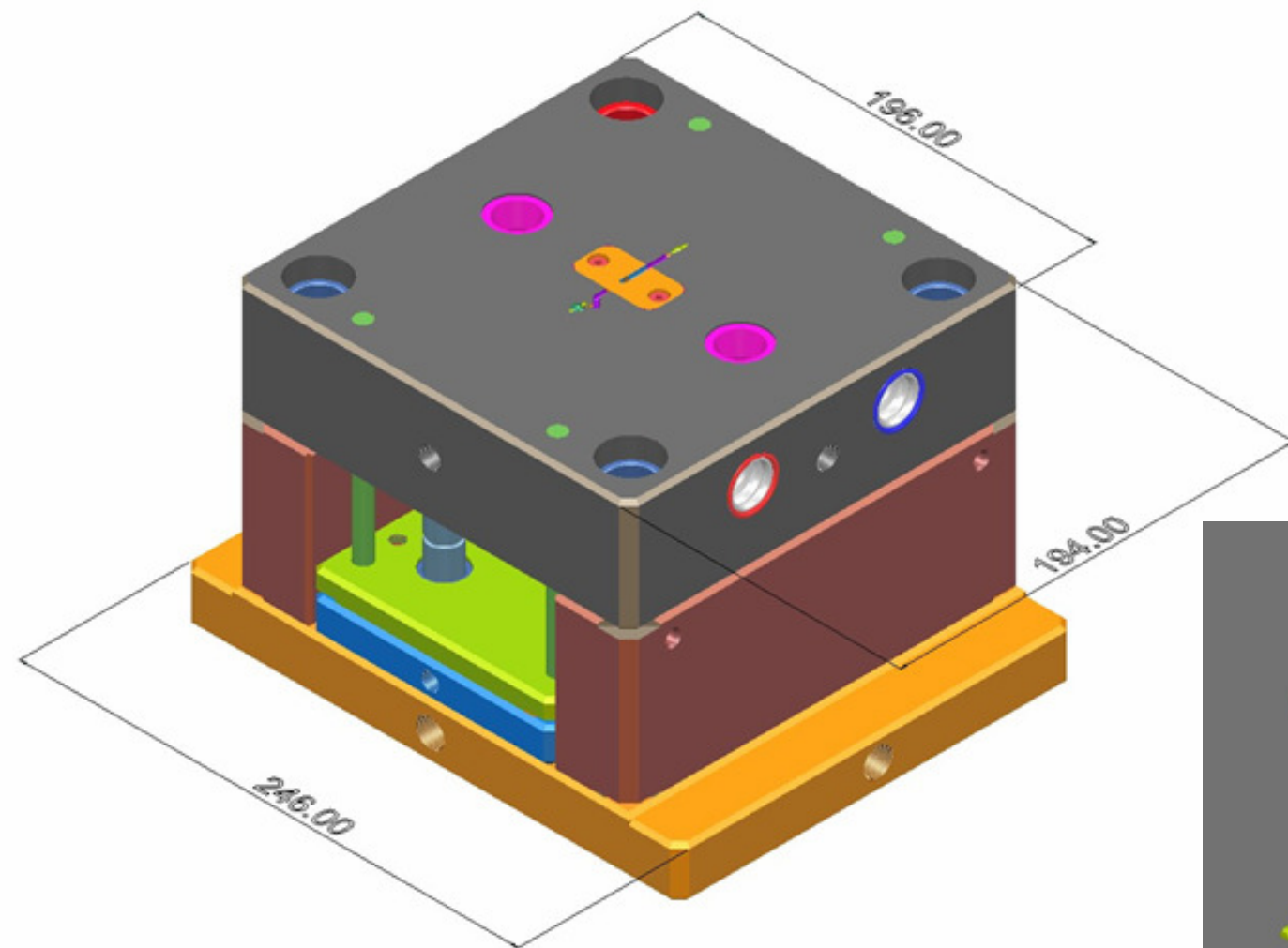



□ IMF (In-Mould Film) Moulds

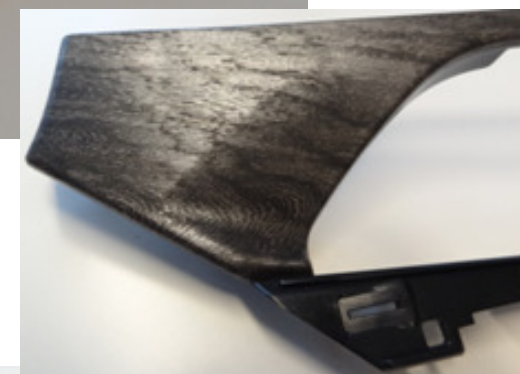
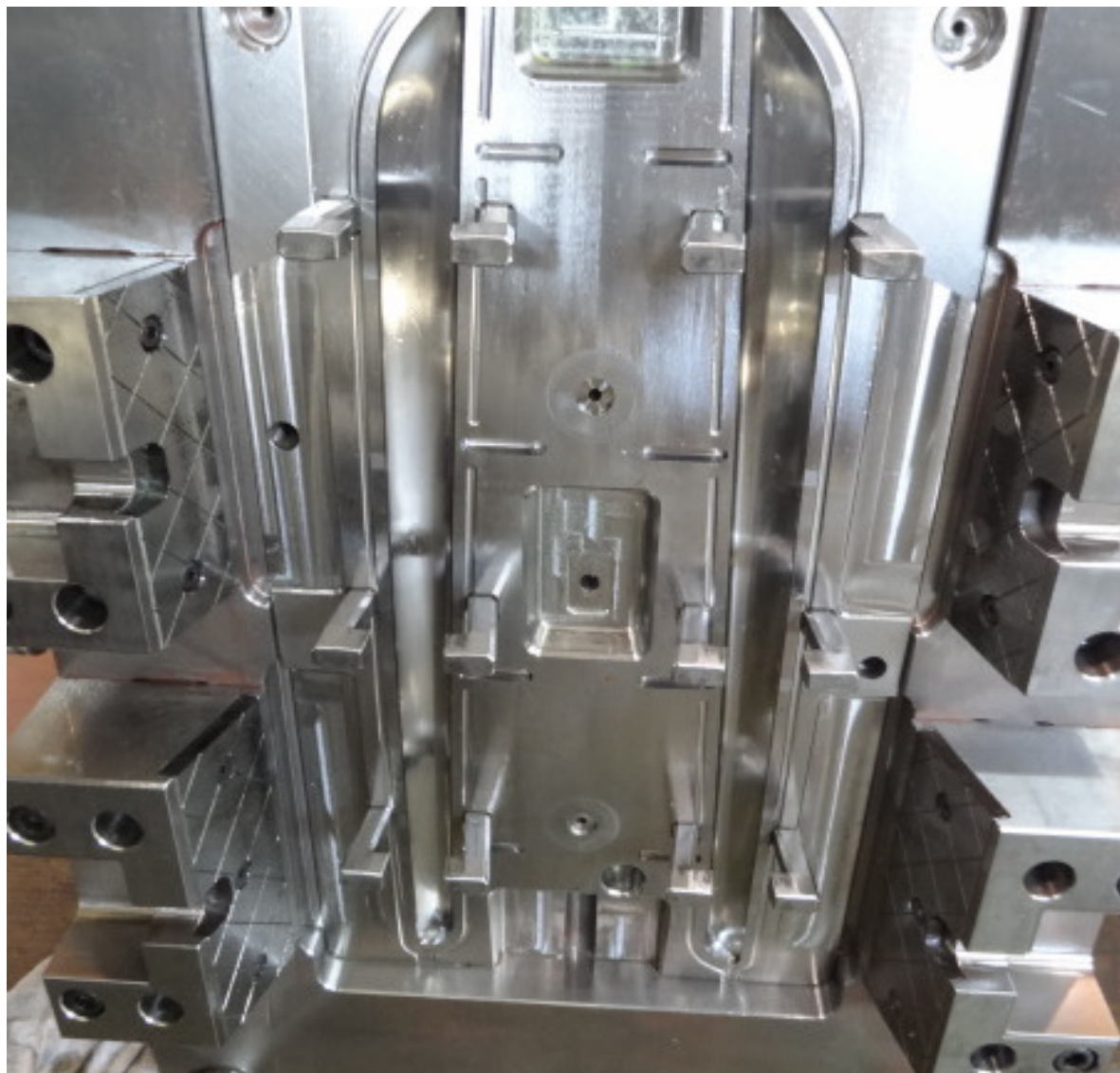



□ Crowning (Distortion Compensation) Mould for MUCCELL

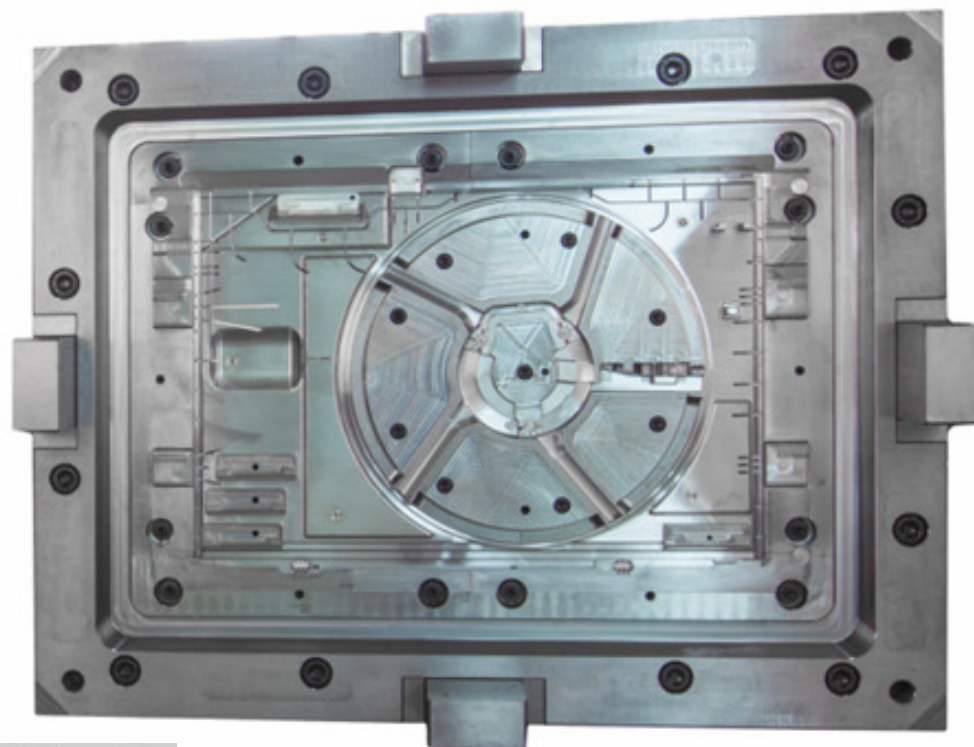
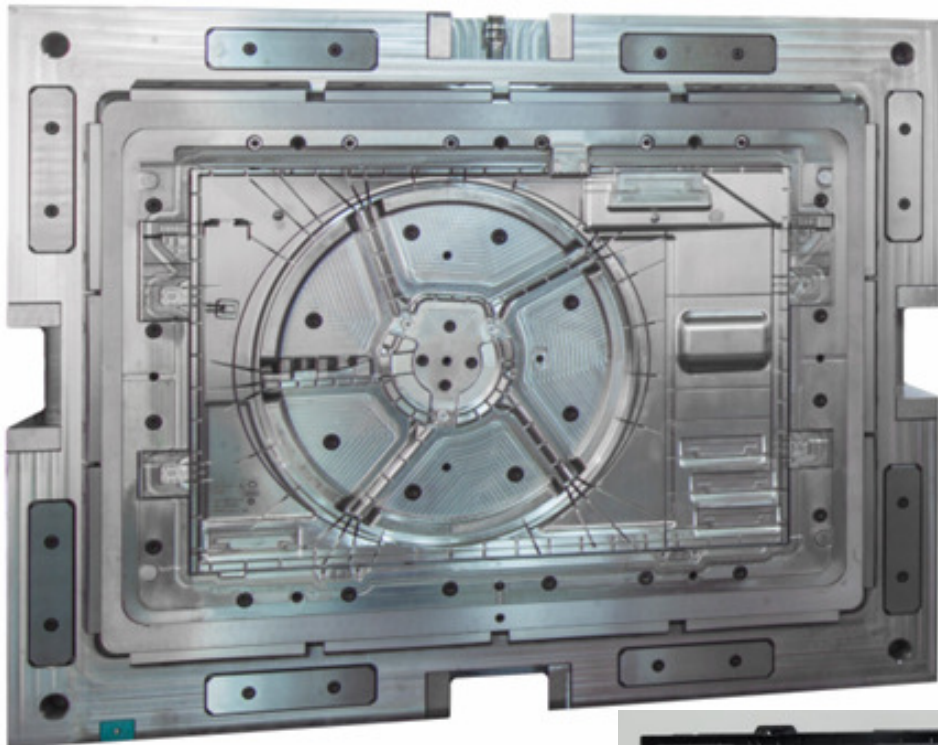



□ Gas Injection Moulds

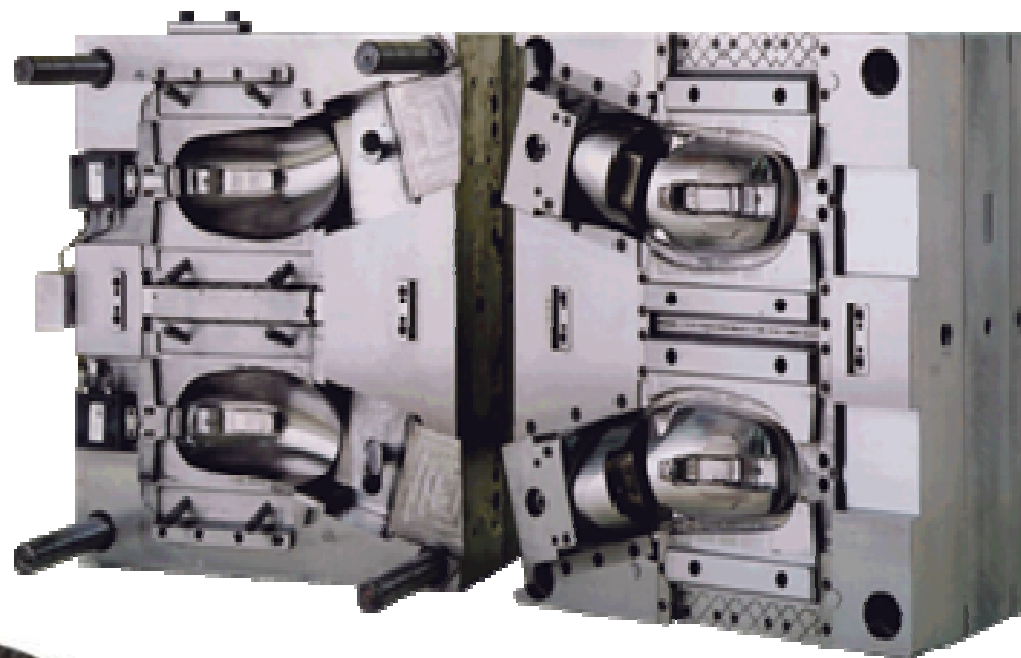
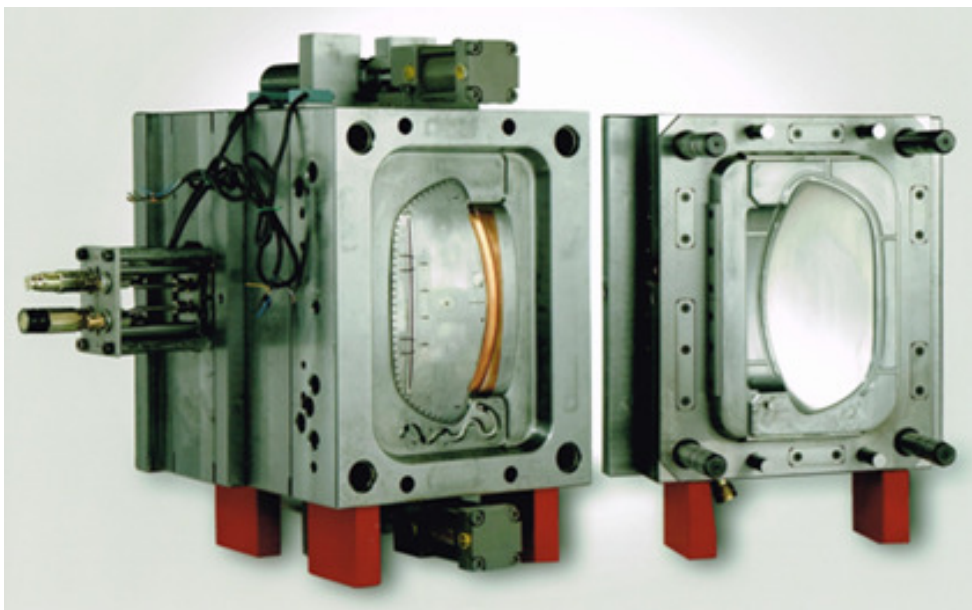



□ High polish Moulds

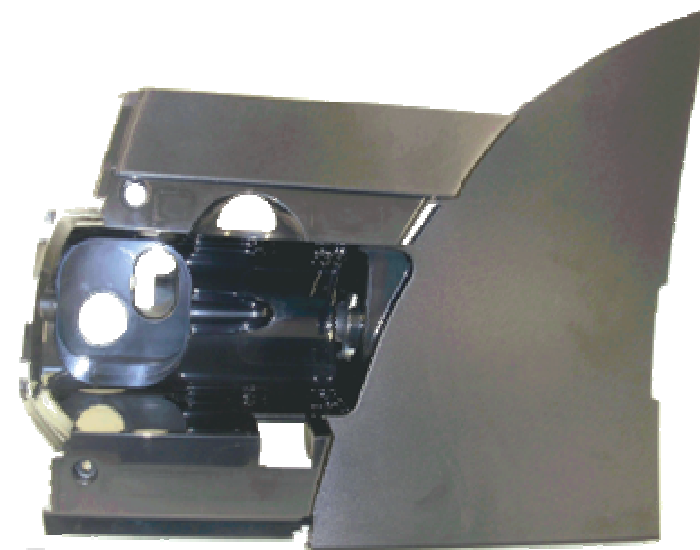
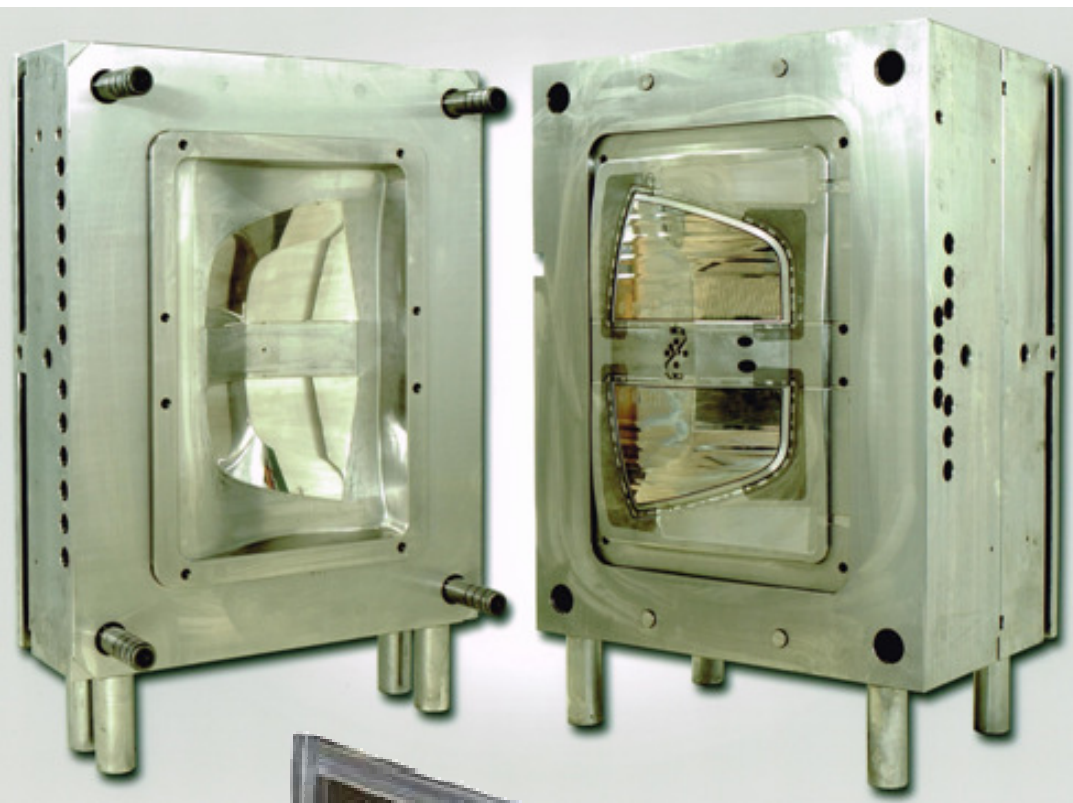



Examples of Moulds

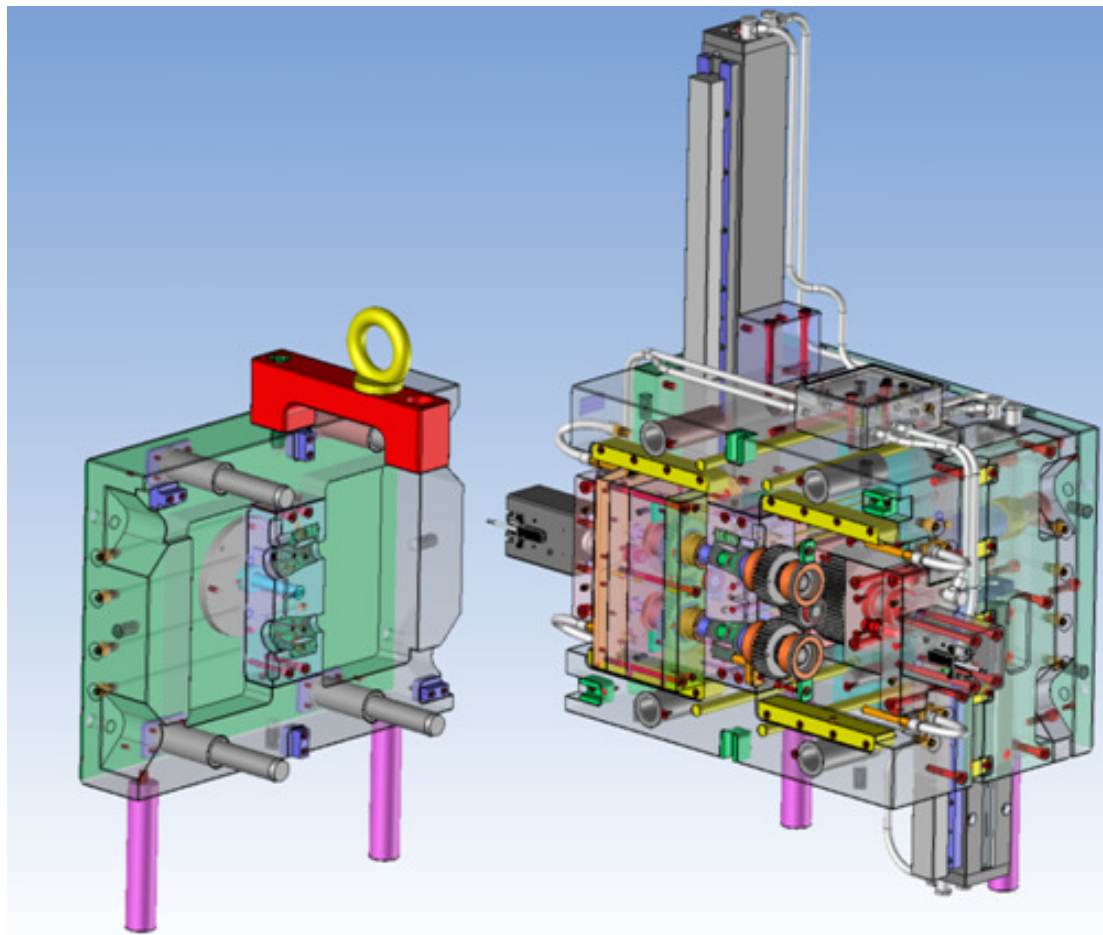

□ Threads Unscrewing





□ Metallic inserts Moulds

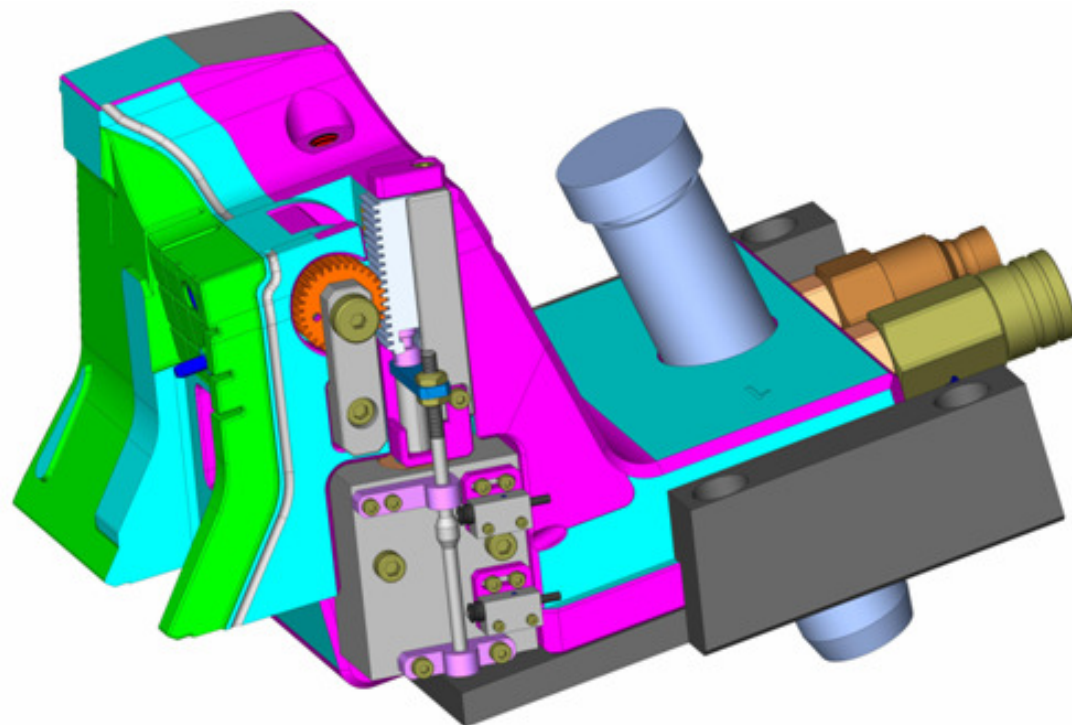
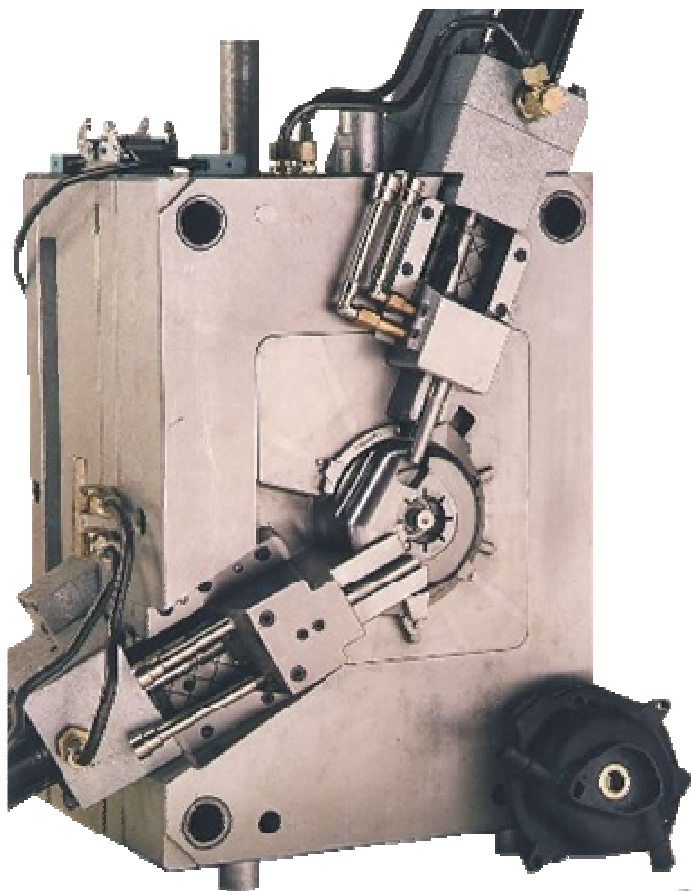

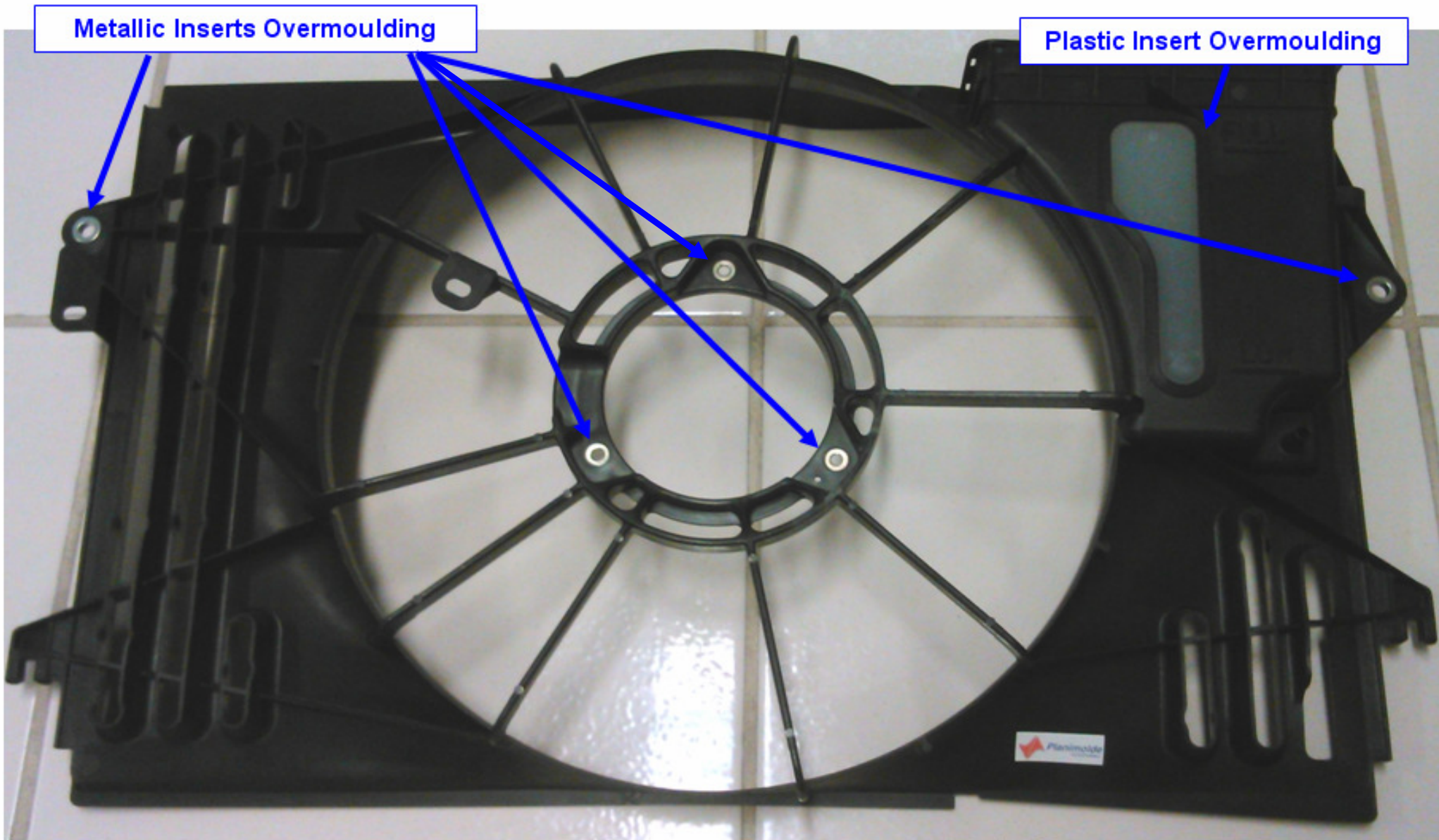



Net Overmoulding



Lighting Parts for Automotive

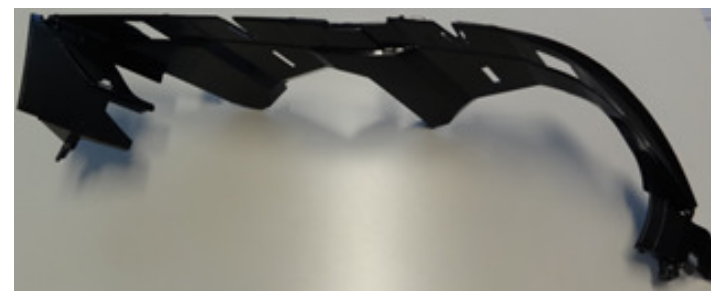



Chromed Parts for Automotive

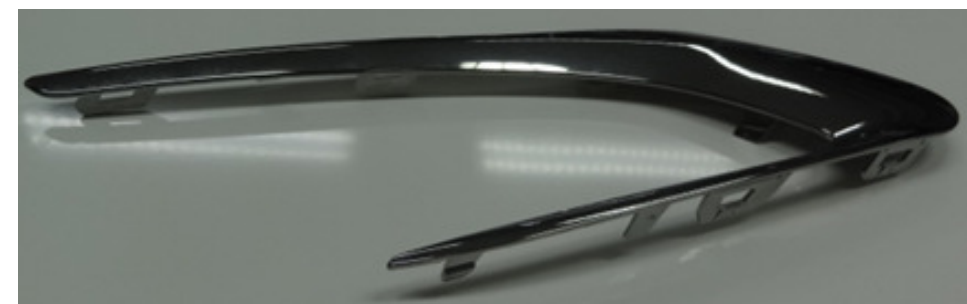
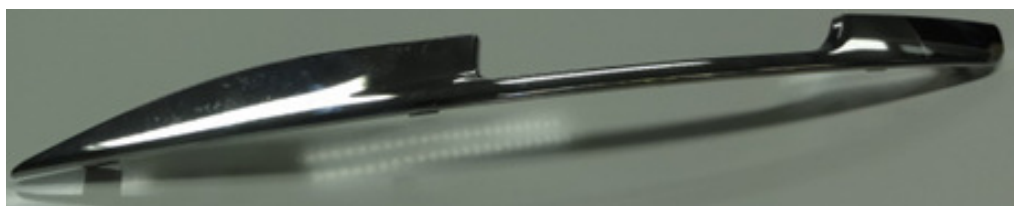



Parts for Electrical

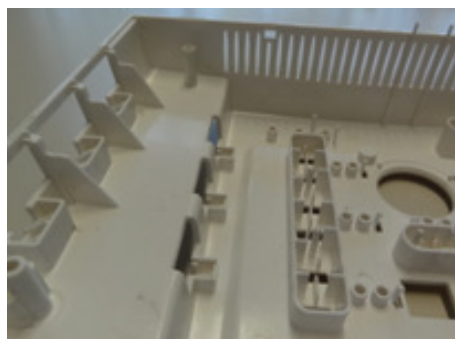
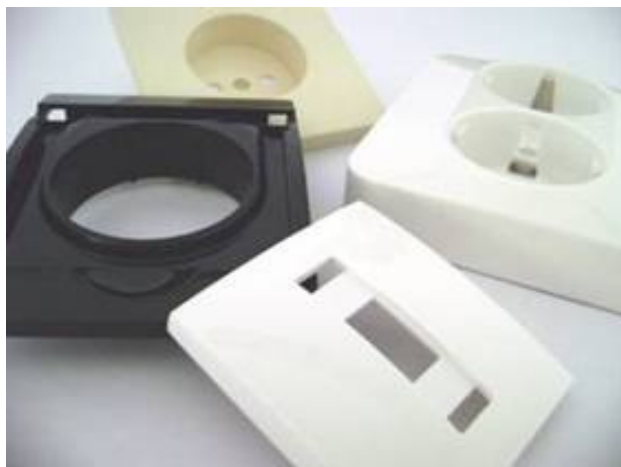

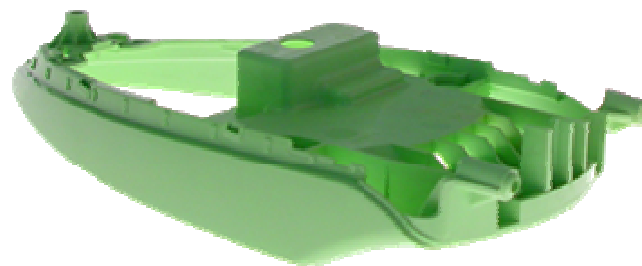
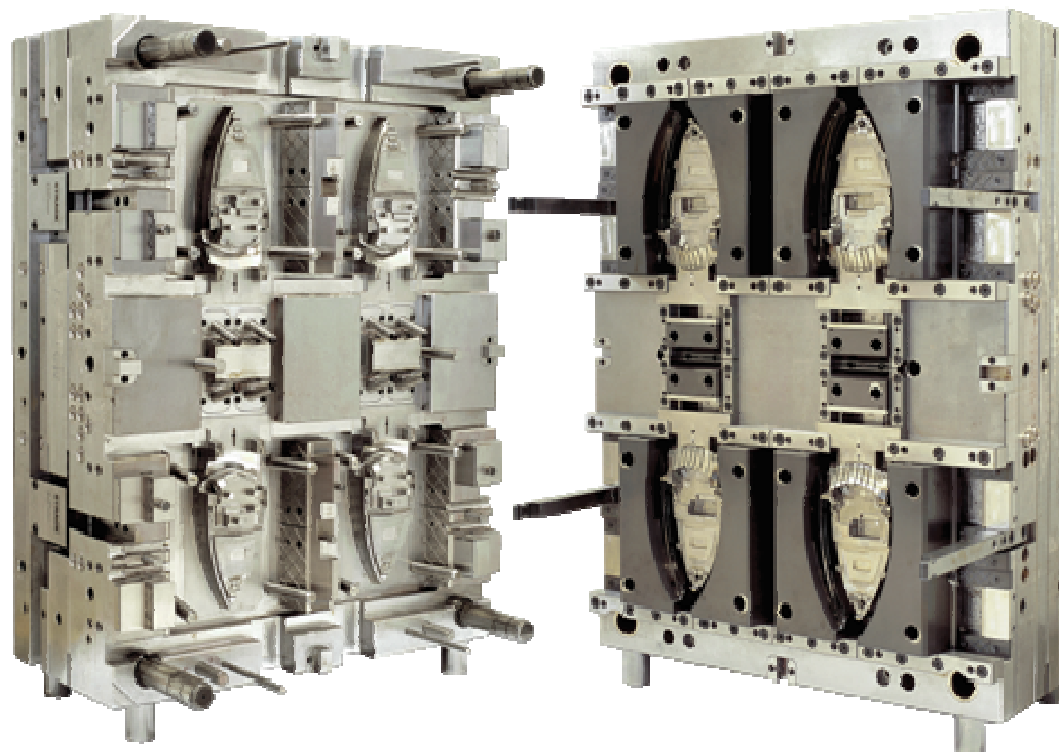
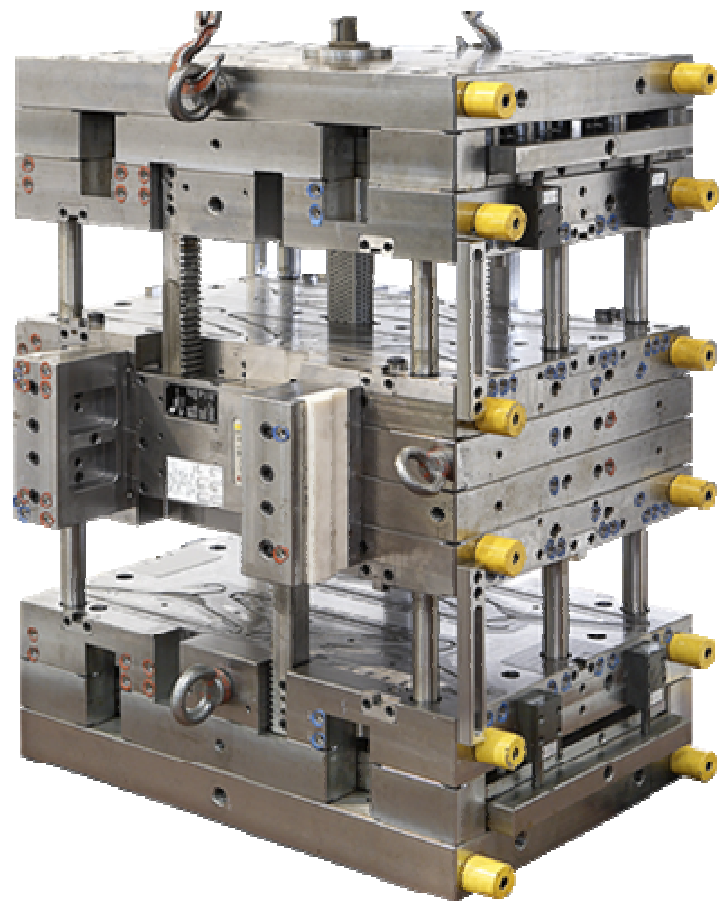



Parts for Houseware

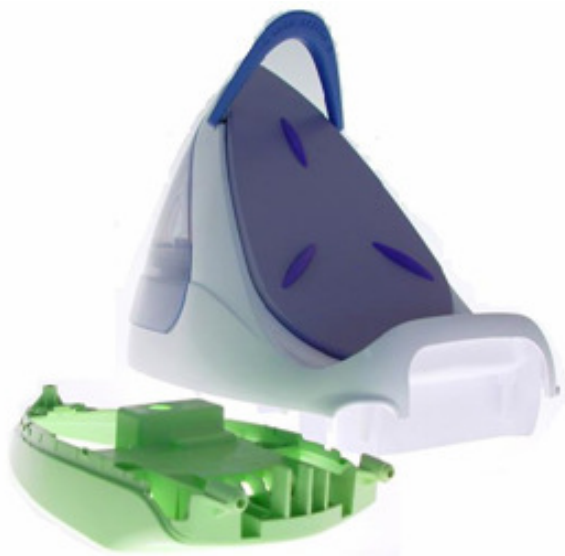



Moulds for Packaging

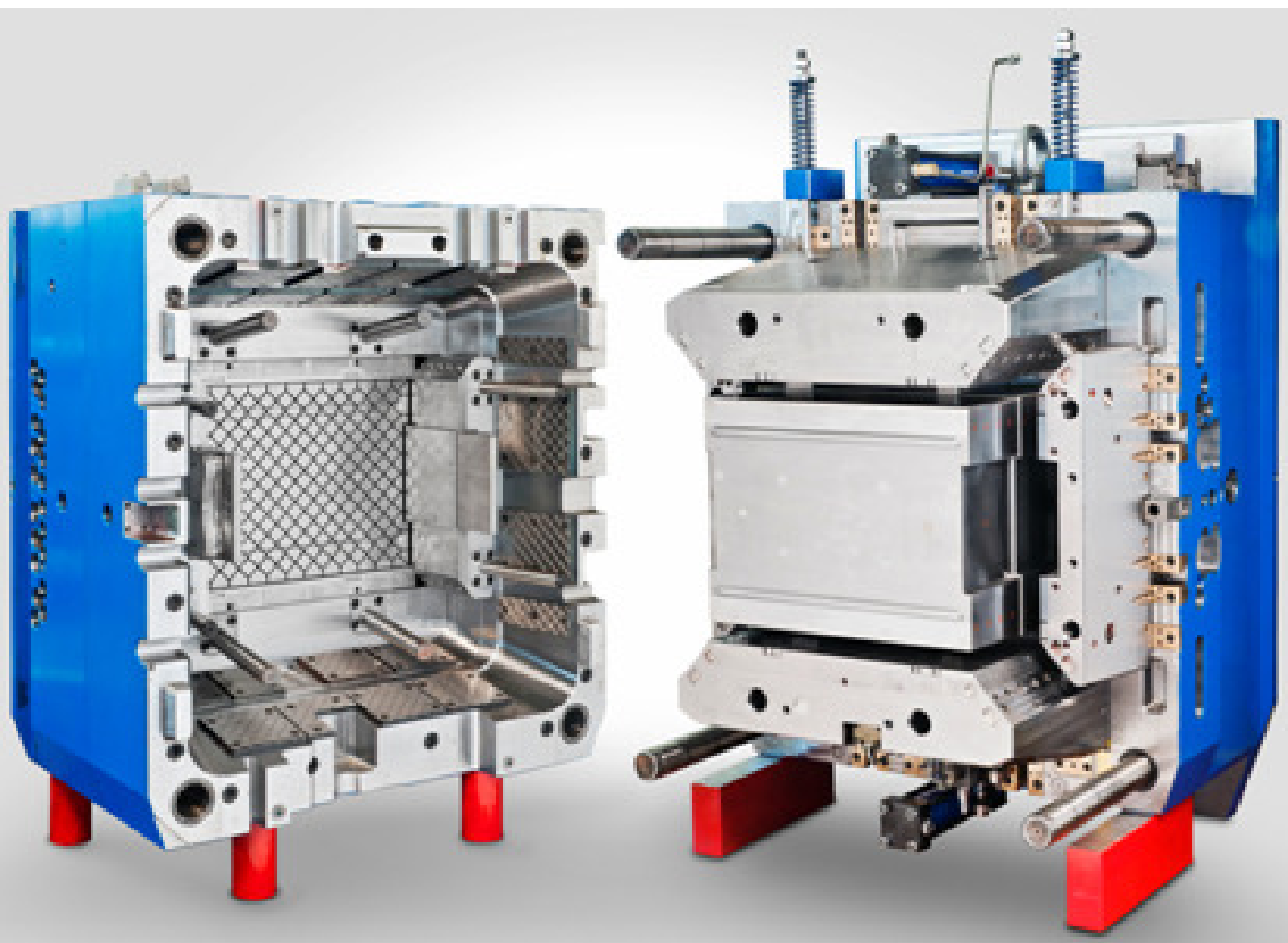



Parts for Packaging









CNC

Vertical Machining Center	1 Mikron HPM 1150 – 5 axes – 24.000 rpm
Vertical Machining Centre	1 Rambdaudi Ramspeed 800E – 24.000 rpm
Vertical Machining Centre	2 Mori Seiki NV500 – 20.000 rpm
Vertical Machining Centre	1 Mori Seiki SVD403 – 20.000 rpm
Vertical Machining Centre	1 Mori Seiki SV – 500B/40 – 20.000 rpm
Vertical Machining Centre	1 Mikron VCE 1600 PRO – 10.000 rpm
Micro-Drilling	1 Agie Charmilles Drill 20
Milling Machine	1 Eumach MC 500
Milling Machines	1 Anayak
EDM Machine	1 Agie Charmilles FO 550 SP
EDM Machine	1 Agie Advance
EDM Machine	1 Agie Mondo Star 50
EDM Machine	1 Charmilles Roboform 200
EDM Machine	1 Ona Basic 30
EDM Machine	1 Ona Basic 50
Wire Cut EDM Machine	1 Agie Charmilles Cut 30P
Wire Cut EDM Machine	1 Charmilles Robofil 290
Surface Grinder	1 Jones & Shipman Techmaster 634 Easy
Turning Lathe	1 Harrison Alpha Plus 460 S
Drilling Centre	1 HETO 1000 Compact

CAD CAM

11 workstations with several softwares:
TopSolid, Cimatron, Mastercam Design,
Mastercam Mill, Autocad, PowerMill,
PowerShape Toolmaker and Solid Edge

CONVENTIONAL

EDM Machines	1 Charmilles
Milling Machines	1 Bridgeport
Milling Machines	1 Deckel
Milling Machine	1 Sachman
Surface Grinder	1 Jones Shipman 540H
Surface Grinder	1 Aba
Surface Grinder	1 Mater 15-8
Surface Grinders	3 Monoprecis
Cylindrical Grinder	1 Jones Shipman
Drilling Machine	1 Foradia
Fitting Press	1 Millutensil
Jig Grinding Machine	1 Hauser

QUALITY CONTROL

3D Co-ordinate Measuring Machine	1 DEA Mistral 100705
Hardness Meter	1 Emcotest
Profile Projector	1 Mitutoyo PH-350-H
Digital Profile Projector	1 TESA V300GL





THE INTERNATIONAL CERTIFICATION NETWORK

CERTIFICATE

**IQNet and
APCER**

hereby certify that the organization

PLANIMOLDE – FABRICO E COMÉRCIO DE MOLDES, S.A.

Rua do Lamarão, Pedrulheira
2430-119 MARINHA GRANDE - PORTUGAL

for the following field of activities

Conception and manufacturing of steel moulds for the plastic and pressure die casting industries

has implemented and maintains a

Quality Management System

Which fulfils the requirements of the following standard

ISO 9001:2008

Issued on: 2013-02-07
Validity date: 2016-01-24

Registration Number: **PT- 1993/CEP.046**



Michael Drechsel
Michael Drechsel
President of IQNet

José Leitão
José Leitão
APCER CEO



Any additional certification concerning the scope of this certificate may be obtained by consulting APCER.

IQNet Partners*

AENOR Spain AFNOR Certification France AIB-Vincotte International Belgium ANCE-ISOE Mexico APCER Portugal CCC Cyprus
CIBQ Italy CQC China CQM China CQB Czech Republic Ccs Cert Croatia DQS Holding GmbH Germany DS Denmark
FCAV Brazil FONDOSORMA Venezuela ICONTEC Colombia IMC Mexico INNOVYS Tunisia
Inspecta Certification Finland IRAM Argentina JQA Japan KQF Korea MIRTEC Greece MSZT Hungary NENKO AS Norway
NSAI Ireland PCBC Poland Quality Austria Austria HR Russia SII Israel SIQ Slovenia SIRM QAS International Malaysia
SQS Switzerland SRAC Romania TEST St Petersburg Russia TSE Turkey YUQS Serbia
IQNet is represented in the USA by: AFNOR Certification, CIBQ, DQS Holding GmbH and NSAI Inc.

* The list of IQNet partners is valid at the time of issue of this certificate. Updated information is available under www.iqnet-certification.com

ISO 9001:2008 Quality Certification





World

Europe



Portugal



Leiria



Marinha Grande

Local interests:



São Pedro de Moel



Batalha



Leiria



Nazaré



Fátima

